

# Fränkische Meisterschaft Ein.-u. Zweispänner Kl.A Bay. und Fränkische Meisterschaft Junioren/U25 Bay. Nachwuchschampionat Junioren/U16

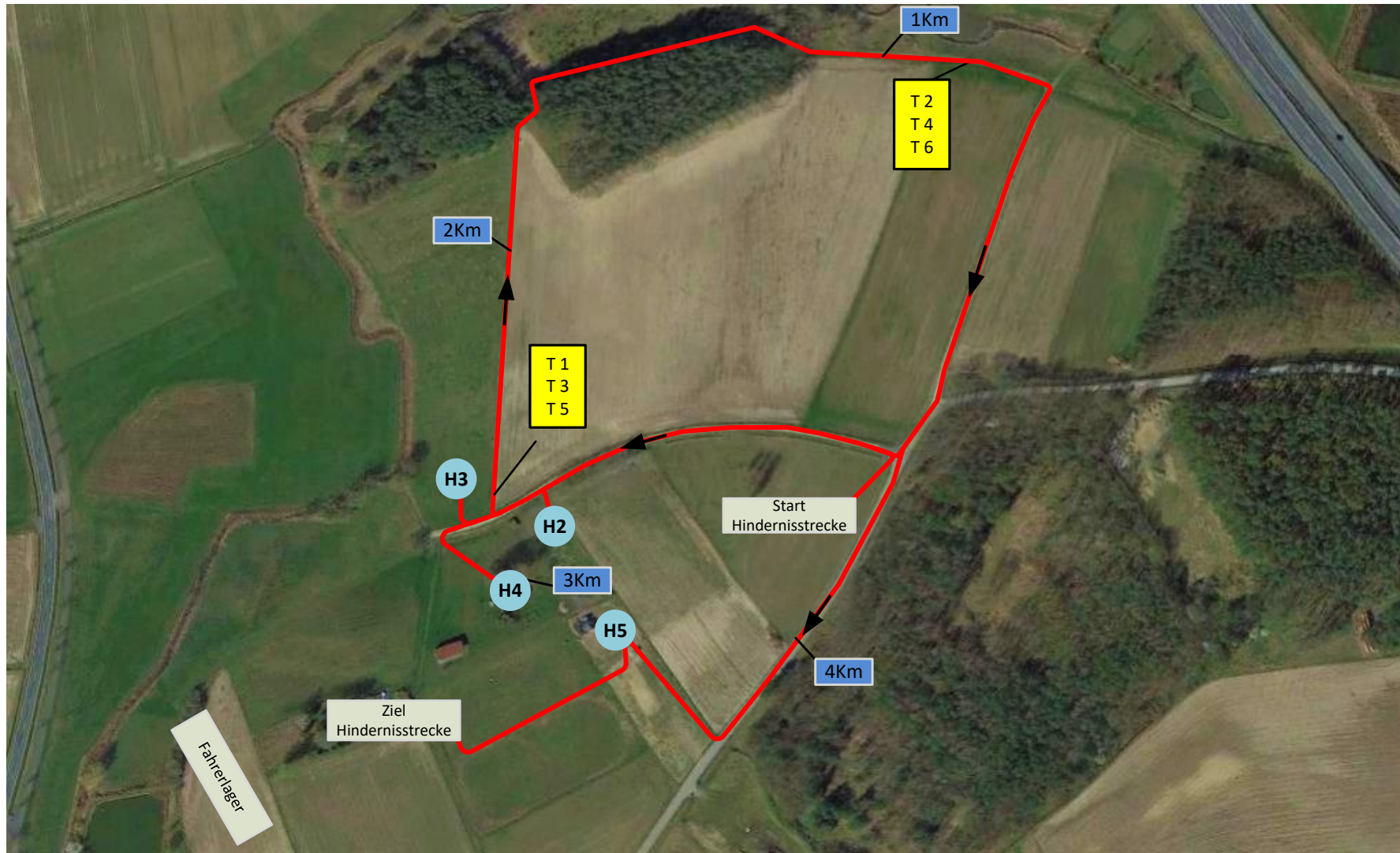

### Streckenführung Hindernisstrecke Kl.A:

Start - H2 - T1 - 1km - T2 - H3 - T3 - 2km - T4 - H4 - 3km - T5 - T6 - 4km - H5 - Ziel

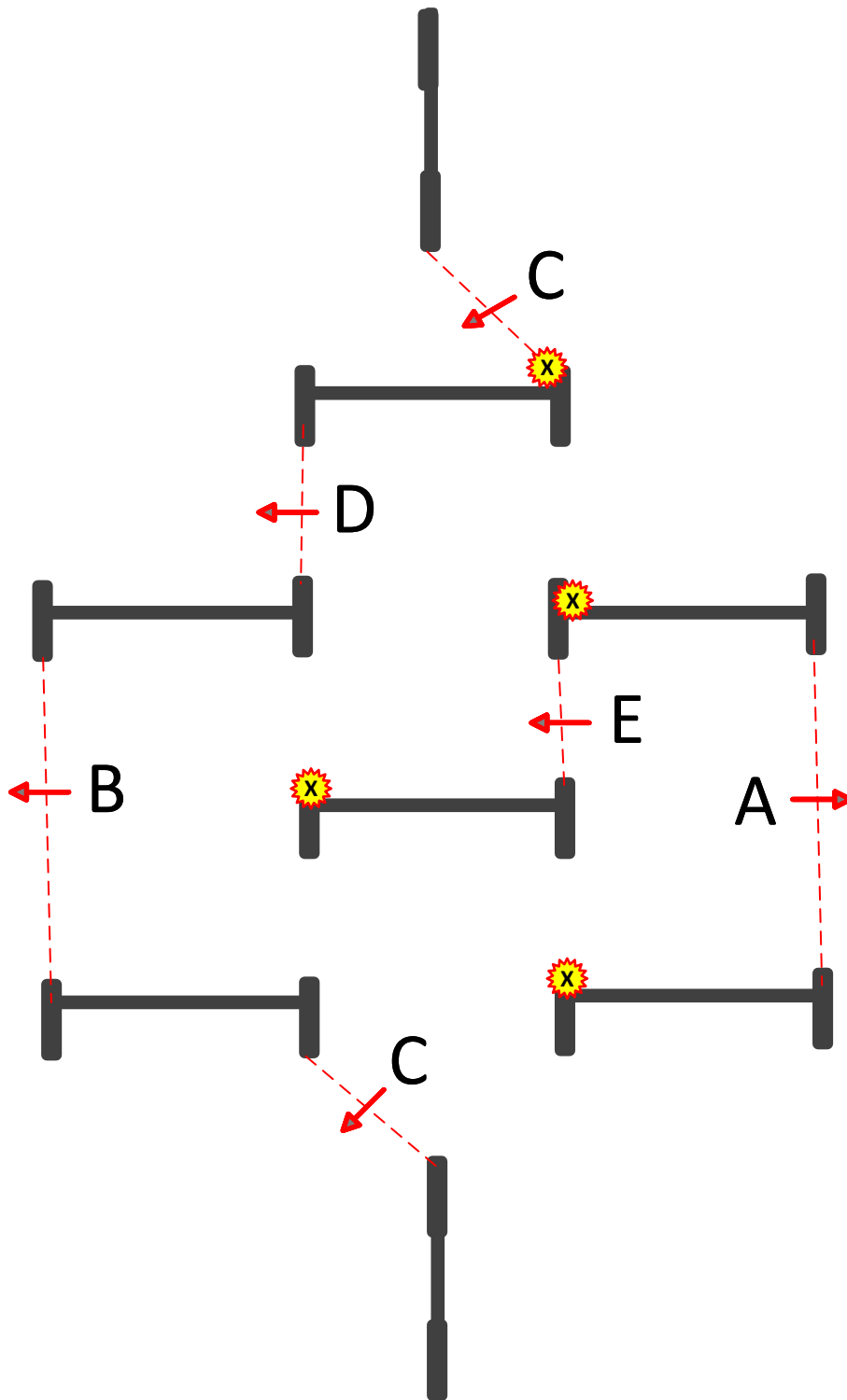
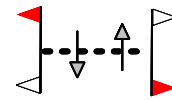

	Kl:A	A – D
	Kl.M	A – E
	Abwerfbare Teile 4	

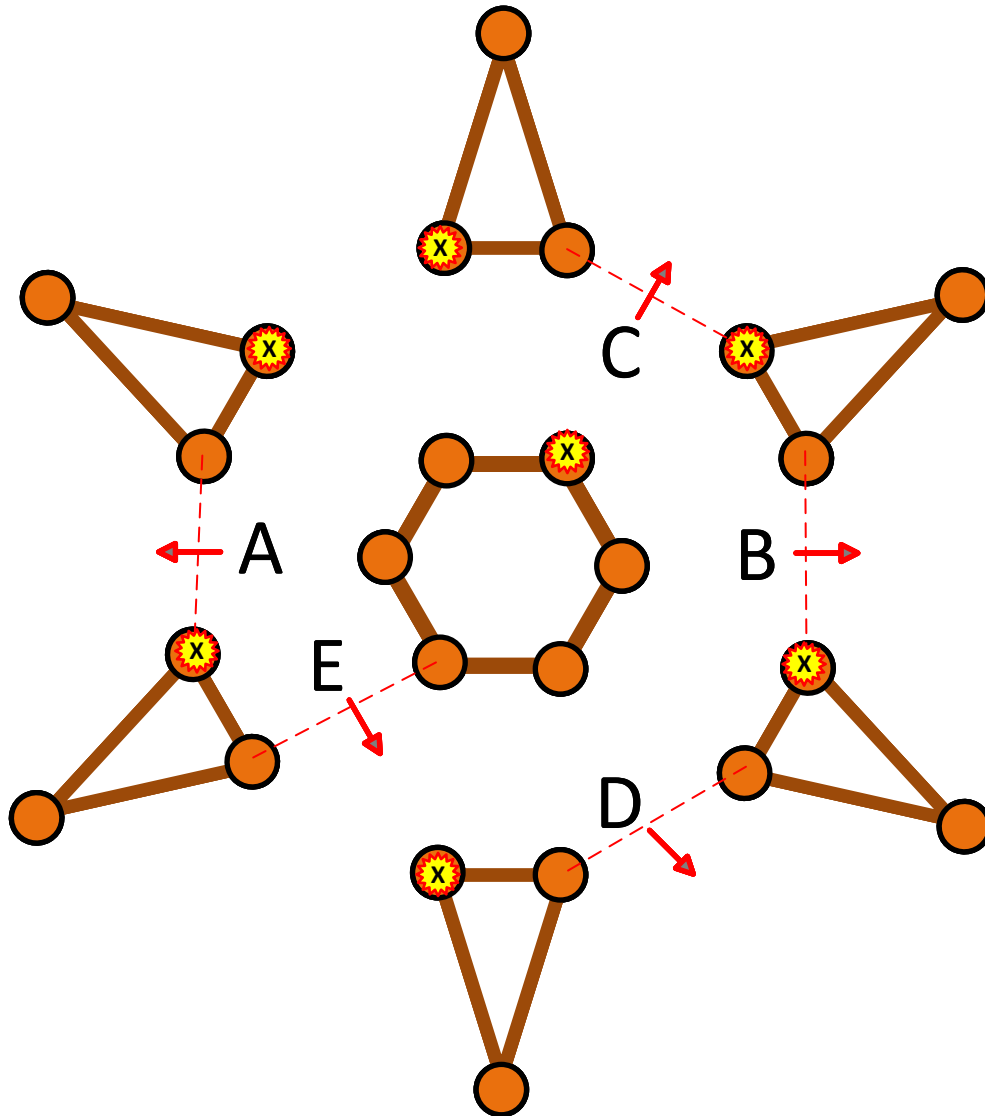

Kl:A	A - D
Kl.M	A - E
Abwerfbare Teile 7	

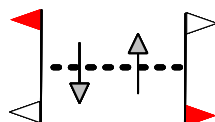

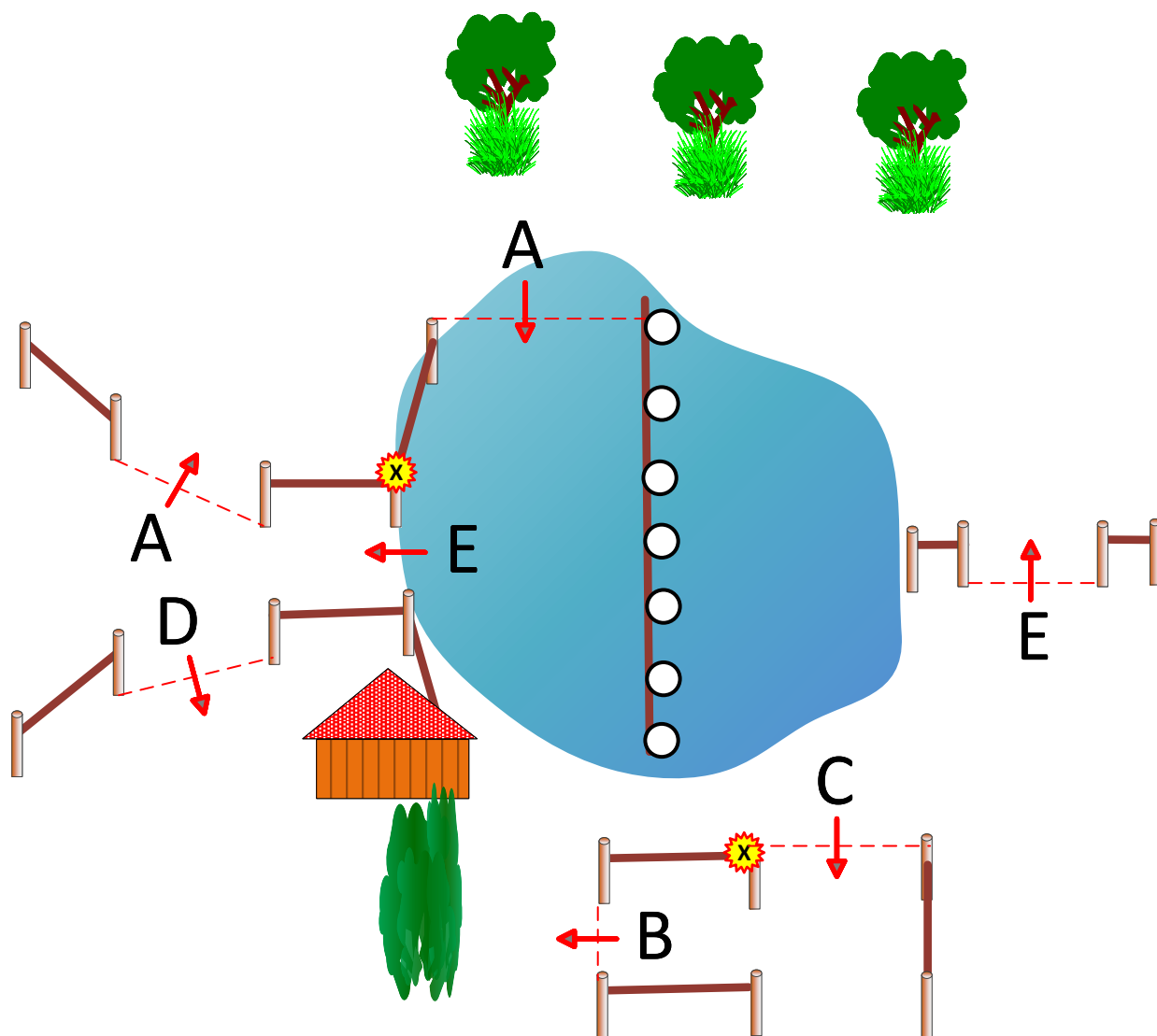
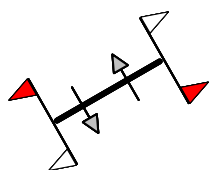

Kl:A A - D  
 Kl:M A - E  
 Abwerfbare Teile 2

Fränkische Meisterschaft Ein.-u. Zweispänner Kl.M,  
 Bay. und Fränkische Meisterschaft Junioren/U25, Bay. Nachwuchschampionat Junioren/U16  
 Niederlindach 13.-15.Aug 2021

© Course Designer: Ludwig Rummelsberger

# Hindernis 5 Frankenbrunnen

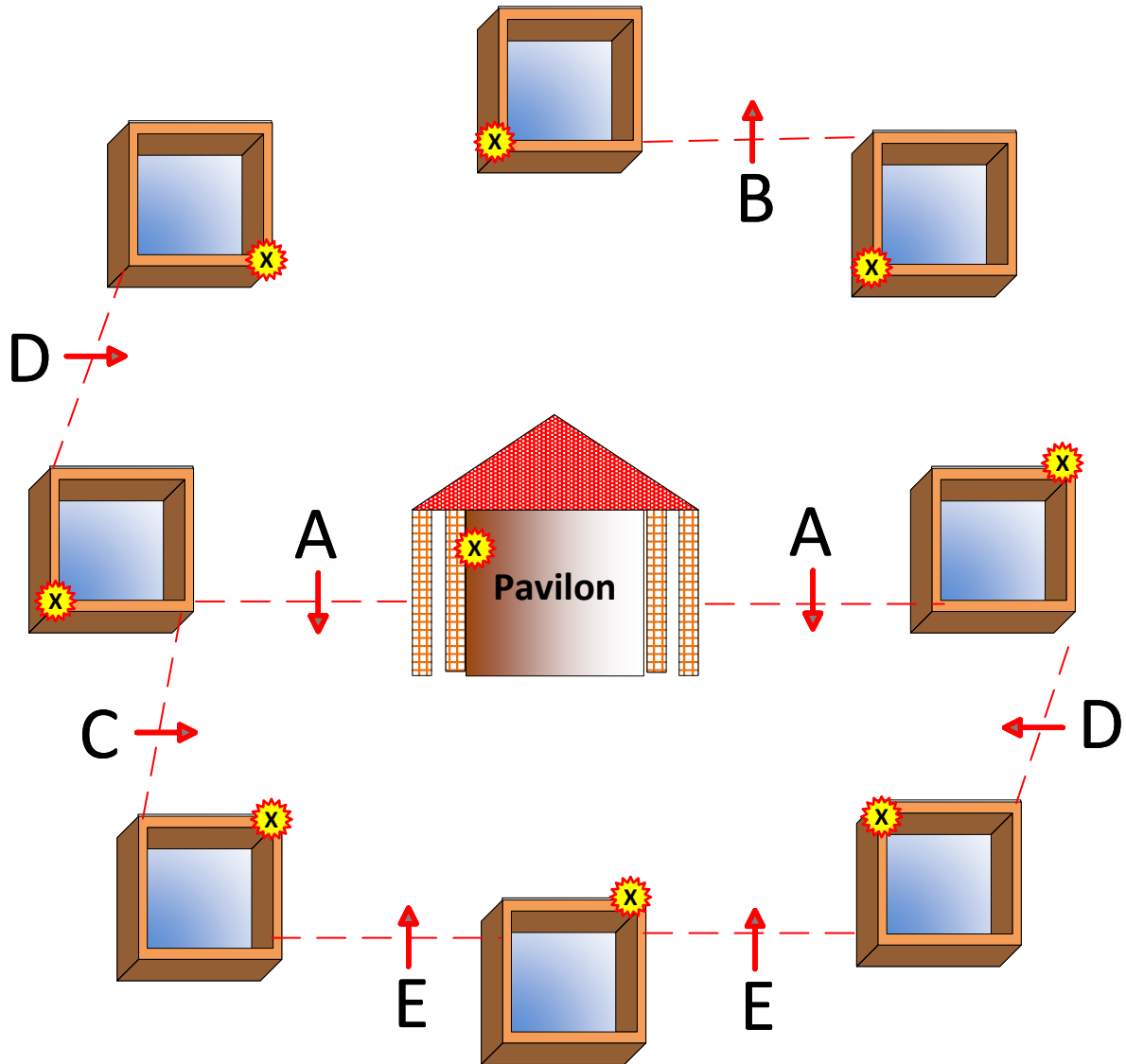

KI:A	A - D
KI:M	A - E
	Abwerfbare Teile 9

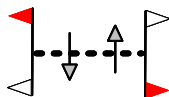

# Streckendaten Kl.A

Fränkische Meisterschaft  
Bayerische Jugendmeisterschaft



der Ein.-und Zweispänner Kl.A / Kl.M  
Niederlindach 13. – 15.Aug. 2021

Prüfung Nr. 21			Ponys	Hindernisstrecke Einspänner Kl.A			
Teilstrecke	Gangart	Länge m	Tempo Km/h	Erlaubte Zeit min:sec	Bestzeit min:sec	Höchstzeit min:sec	Pflichttore
Hindernisstrecke	Beliebig	4600	12	23:00	20:00	46:00	1 bis 6
Streckenführung Hindernisstrecke: Start - H2 - T1 - 1km - T2 - H3 - T3 - 2km - T4 - H4 - 3km - T5 - T6 - 4km - H5 - Ziel							

Prüfung Nr. 22			Pferde	Hindernisstrecke Einspänner Kl.A			
Teilstrecke	Gangart	Länge m	Tempo Km/h	Erlaubte Zeit min:sec	Bestzeit min:sec	Höchstzeit min:sec	Pflichttore
Hindernisstrecke	Beliebig	4600	13	21:14	18:14	42:28	1 bis 6
Streckenführung Hindernisstrecke: Start - H2 - T1 - 1km - T2 - H3 - T3 - 2km - T4 - H4 - 3km - T5 - T6 - 4km - H5 - Ziel							



Ein großes „Dankeschön“  
an allen Spendern  
und Helfern